

Orbital welding (Closed heads)



Our new range of closed SATFX welding heads enables you to achieve high quality welds in a minimal space.

Orbital welding with a closed head is done by a **simple fusion without additional wire feeding**. Consequently, these heads are recommended for welding **thin tubes of many types of stainless steel** with thicknesses of less than 3 mm.

SATFX heads are also indispensable for welding other nickel or titanium based alloys which are very sensitive to oxidation and are used when an installation with an impeccable resistance to chemicals or heat is required.



The new SATFX heads have been designed to meet the needs of our customers who are often confronted with the most demanding welding specifications.

The protective atmosphere provided by the closed heads permits welding in an inerting chamber. This results in **welds with very minimal discoloration and perfectly clean weld beads**.

This type of equipment is used in **industrial sectors sensitive to hygienic conditions** such as aeronautics, semi-conductors, pharmaceuticals as well as food and beverage processing.

The narrow width of the head makes it ideal for construction sites where only a small amount of straight sections are in demand. However, these welding heads are also used in workshops and clean rooms.

The SATFX range, coupled with our SAXX welding power supplies and their continuous monitoring of welding parameters, guarantee **repeatable welds of high quality**. This type of weld passes the most strenuous tests, such as X-ray inspection.

*contact us for more information

FLEXIBILITY, PRODUCTIVITY



Productivity remains our top priority. The liquid cooling circuit has been optimized to allow for **greater heat evacuation** and thus:

- increases the service life of the SATFX
- guarantees a substantial welding output. The operating current at 100% is **100 A**.

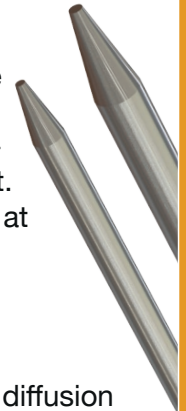

QUALITY AND REPEATABILITY

Direct wire feeding and a homogeneous diffusion of the inert gas, high quality materials and special component processing, a grease-free operation, easy maintenance and cleaning plus numerous configurations make the SATFX range the ideal response to the requirements of high-tech industries.

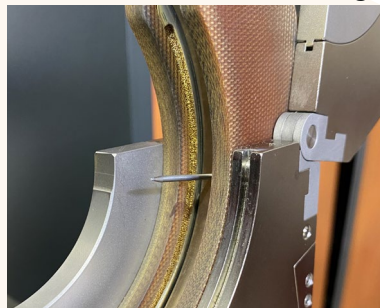

They allow for intense, versatile and long-lasting usage on your construction sites and in your workshops.

INNOVATION : GLOBAL PROCESS 2 in 1

The SATFX closed welding heads can easily be transformed into a cassette machine. The cassette allows for easy placement on the parts to be welded in confined areas. Welding without tacking is possible under certain conditions.*

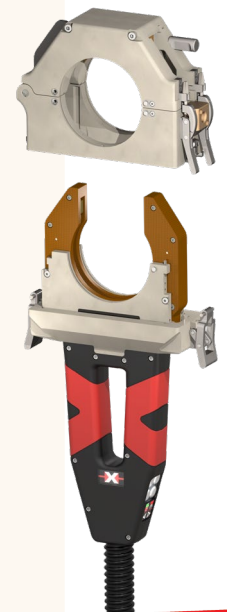

Please do not hesitate to contact us for all enquiries relating to orbital welding technology.

We will be glad to share our know-how with you and to devise a solution that best meets your needs!



NEW

SATFX-52 - 76 - 115

AXXAIR
INNOVATIVE ORBITAL SOLUTIONS

High protection against arcing outside the electrode

Power drive system with encoder: allows starting in all angular positions of the electrode

Water cooling of the electrode holder and aluminium flanges.

Standard stainless steel jaws for quick assembly without tools.

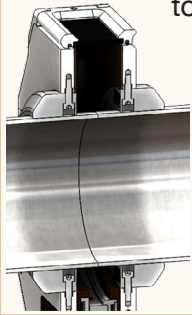

Wide aluminium jaws for optimal machine stability when welding accessories.

Illuminated logo on each side

Operating **without grease:** compatible with clean room standards.

Length of the cable: **8 meters**



Large pivoting window with welding glass to check the electrode alignment after tightening the two frames.

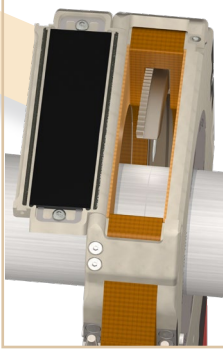

The welding glass (grade 10) allows to observe the weld and protect the operator's eyes.

Closing system with adjustable force without tools. Allows precise adjustment of the force of the jaws on the tube to be welded and helps opening after welding.

Perfect gas protection in the welding head.

Optimized handling: **Ergonomic design with soft touch compound areas** and overall **weight greatly reduced.**

4 stainless steel remote control buttons.

Global Process : 2 in 1

Cassettes for welding in confined areas.

Easy positioning of the cassette on the parts to be welded before fixing the central body of the head.



These heads are delivered in a water- and dustproof **suitcase** and with a **suspension assembly.**

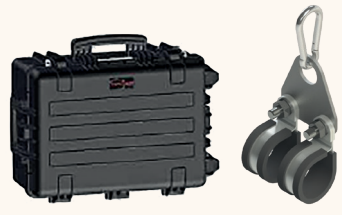

Welding range	
SATFX-52	∅ 6 - ∅ 52 mm 0.25 - 2 "
SATFX-76	∅ 6 - ∅ 77 mm 0.25 - 3 "
SATFX-115	∅ 12 - ∅ 115 mm 0.5 - 4.5 "



Join **experience**



NEW

SATFX-52 - 76 - 115

AXXAIR
INNOVATIVE ORBITAL SOLUTIONS

Technical characteristics:

Maximum welding current	150 A
100% duty cycle	100 A

These closed heads are designed for orbital butt TIG welding of tubes, tubes-elbows, tube-ferrules, tubes-T, tubes-fittings and others in a fully inerted closed chamber.

The SATFX heads are driven by the AXXAIR orbital welding power sources of the SAXX range.

Integral water cooling of the heads and new treatment of the aluminium parts offering a better electrical and thermal conductivity. The double cooling of the rotor and the head body is essential to guarantee a **good lifespan of the parts** by minimizing the effects of expansion deformation.

Illuminated logo on each side of the head : it allows to visualize if the power source is turned on or off and if the machine is in a welding cycle or not.

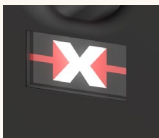

When the power source is powered on and the head connected, the light is on steady. When the machine is welding, the indicator light flashes.



4 stainless steel remote control buttons: Start/stop, gas purging, rotation of the rotor in one direction and rotation in the other direction. Regardless of the starting position during welding, the rotor automatically returns to the open position of the rotor so that the welded parts can be removed easily.

Ergonomic design:

Ergonomic handle with soft touch overmolding that brings the hand closer to the center of gravity of the head, providing unparalleled handling comfort.

Maintenance :

All rotation axes and toggle clamps can easily be changed.



Cleaning: A single hexagonal wrench allows the machine to be disassembled in a few minutes to clean the interior, without having to empty the head's coolant circuit.

Gas diffusion: more direct gas supply through two sintered bronze semi-circular bunds. This allows a trouble-free distribution and flow, even with a high gas flow rate and without blowing out the arc.

Max flow rate: 60l/min

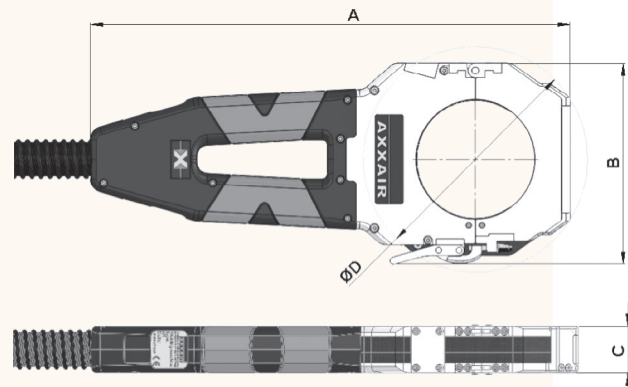

Thickness of 37.6 mm: possibility to weld with the stainless steel jaws standard microfitting fittings or other accessories with a straight part of 19.1 mm.

Product Code	Description	Tube welding machine for the following diameters	Net weight with cable	Dimensions A x B x C in mm	Dimensions D
SATFX-52	Water-cooled closed head with 8m cable for SAXX welding power sources	ø 6 - ø 52 mm	8.6 kg	375 x 142 x 37,6	ø 160 mm
SATFX-76		ø 6 - ø 77 mm	8.9 kg	399 x 166 x 37,6	ø 187 mm
SATFX-115		ø 12 - ø 115 mm	9.4 kg	439 x 206 x 37,6	ø 242 mm



Join **experience**



NEW **Orbital welding (Closed heads) - Accessories**
Cassettes



Global Process 2 in 1

These cassettes are intended to be mounted on the closed welding heads of the SATFX range. They allow the operator to perform welds in a cramped and restrictive environment, where it is difficult to operate these welding machines.

When the cassette is in place on the tubes or accessories to be welded, the operator only has to fix the machine body in the cassette and then start the welding program from the power supply or from the welding head's keyboard.

Flexibility: The SATFX heads can be quickly converted to cassette machines and vice versa.

Please note that the cassettes can be ordered later on.

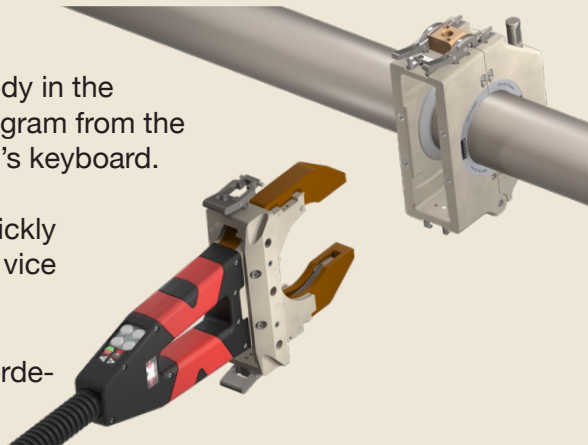

Thin and wide clamping jaws can be used.

Stop blade for placing the cassette on a single tube or accessory and tacking with the SATFX head.

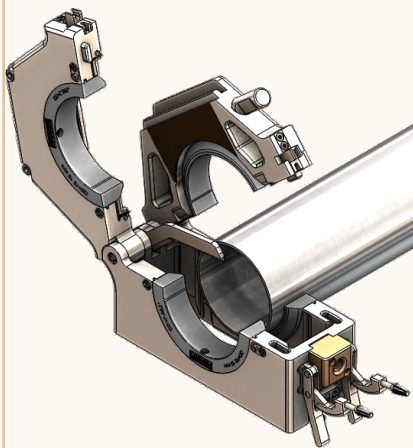

Positioning pen for placing the cassette on two tubes or accessories in line, already tacked.

The tip of the pen represents the tip of the electrode.

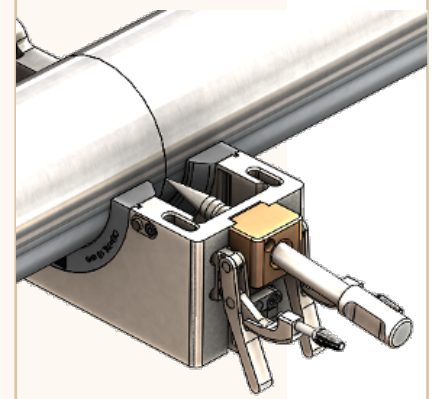

Interface to be fixed on the welding head.

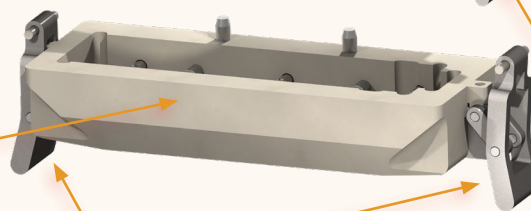

The cassettes benefit from the same **closing system with adjustable force without tools** that allows precise adjustment of the jaw force on the tube to be welded and assists opening after welding.

Cassette clamping lever on machine.



NEW Orbital welding (Closed heads) - Accessories
Cassettes

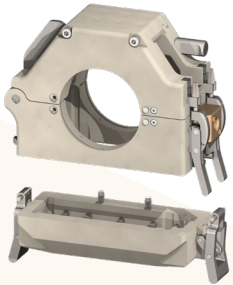

Product Code	Description	Net weight	Packaging (in cm)
SATFX52-CA01	Cassette for SATFX-52	2,3 kg	30 x 30 x 15
Cassette to be mounted on the SATFX-52 closed welding head for welding in confined spaces . Easy positioning of the cassette on the parts to be welded before fixing the central body of the head.			
✓ SATFX-52	SATFX-76		SATFX-115

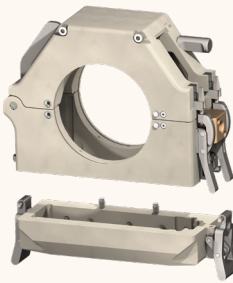

Product Code	Description	Net weight	Packaging (in cm)
SATFX76-CA01	Cassette for SATFX-76	2,7 kg	30 x 30 x 15
Cassette to be mounted on the SATFX-76 closed welding head for welding in confined spaces . Easy positioning of the cassette on the parts to be welded before fixing the central body of the head.			
SATFX-52	✓ SATFX-76		SATFX-115

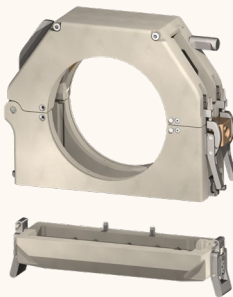

Product Code	Description	Net weight	Packaging (in cm)
SATFX115-CA01	Cassette for SATFX-115	3,5kg	30 x 30 x 15
Cassette to be mounted on the SATFX-115 closed welding head for welding in confined spaces . Easy positioning of the cassette on the parts to be welded before fixing the central body of the head.			
SATFX-52	SATFX-76		✓ SATFX-115

	SATFX52-CA01	SATFX76-CA01	SATFX115-CA01
A	158	182	222,5
B	123,5	147,5	188
C	72	84	104
D	182,5	206,5	246,5
ØE	175	199	238
F	68,1	68,1	68,1
G	34,05	34,05	34,05

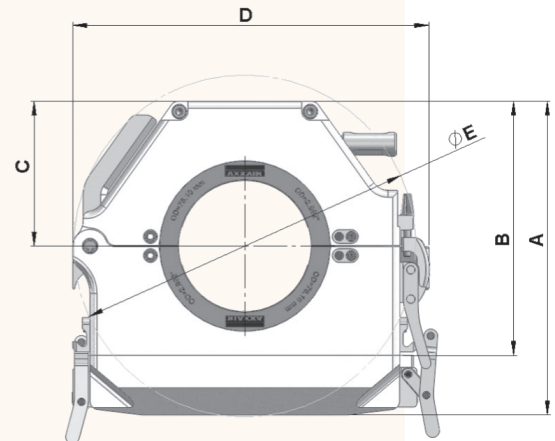
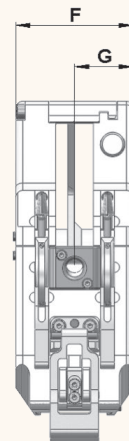

Orbital welding (Closed heads) - Accessories



NEW



Product Code	Description	Net weight	Packaging (in cm)
SATFX-SUP	Machine support	1.39 kg	20 x 20 x 20

This modular support allows the installation of the machine on all possible types of support (workbench, barrier, etc...).

✓ SATFX-52	✓ SATFX-76	✓ SATFX-115
------------	------------	-------------

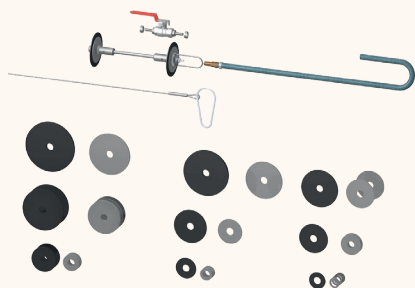

Product Code	Description	Net weight	Packaging (in cm)
SKIF-01	Gas protection KIT	4.5 kg	35 x 30 x 9.5

Gas membrane protection KIT for tubes Ø 40 to 120 mm
 - consists of: 9 sets of membranes with washers, 1 gas pipe 6 m, 1 metal cable, 1 ¼ turn gas valve, 1 carabiner

Inerting the tubes during welding allows more gas savings as we only inert the area to be welded.

✓ SATFX-52	✓ SATFX-76	✓ SATFX-115
------------	------------	-------------

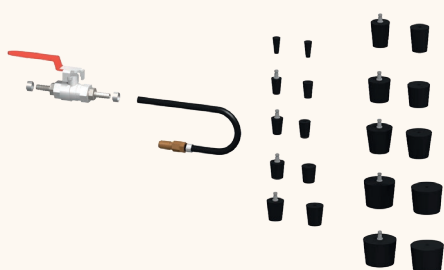

Product Code	Description	Net weight	Packaging (in cm)
SKIB-01	Gas protection KIT	1.7 kg	35 x 30 x 9.5

Gas plug protection KIT for tubes Ø 6 to 41 mm
 - Consists of: 10 sets of perforated plugs, 1 gas inlet connector, 1 hose Ø 4/6 length 5 metres

Facilitates and accelerates inerting. Avoids the use of adhesive paper.

✓ SATFX-52	✓ SATFX-76	✓ SATFX-115
------------	------------	-------------



To increase the operating distance between the welding head and the SAXX power source, we offer cable extensions.

In order to guarantee the proper functioning of the machine, a **maximum length of 20m of extension or a maximum quantity of 2 extension cables** is recommended. For a higher need, please consult us.

Cooling and use	Length	Product Code	Net weight	Dimensions (AxBxC in mm)
WATER - WITHOUT WIRE	5 metres	SAFS-05MX	7 kg	40 x 59 x 25
	10 metres	SAFS-10MX	14 kg	40 x 59 x 25

✓ SATFX-52	✓ SATFX-76	✓ SATFX-115
------------	------------	-------------



Orbital welding (Closed heads) - Accessories



Thin clamping jaws, thickness 8 mm, stainless steel

A set of thin clamping jaws consists of **four half-shells** machined to the outside diameter of the tube.

For Machine	Product Code	Net weight	Packaging (plastic)
SATFX-52	SMN052-xx	Depending on the tube \varnothing	7.5 x 8 x 3 cm
SATFX-76	SMN076-xx	Depending on the tube \varnothing	11 x 11.5 x 3 cm
SATFX-115	SMN115-xx	Depending on the tube \varnothing	17 x 18 x 3 cm

To order the jaws, replace xx with the outside diameter of the tube you want to weld.
 Example: A set of jaws for clamping a tube with an outside diameter of \varnothing 38.10 mm = SMN052-38.1

✓ SATFX-52	✓ SATFX-76	✓ SATFX-115
------------	------------	-------------



Wide clamping jaws, thickness 22 mm, aluminium

One set of wide jaws consists of **two half shells** machined to the external diameter of the tube.

For Machine	Product Code	Net weight	Packaging (plastic)
SATFX-52	SML052-xx	Depending on the tube \varnothing	7.5 x 8 x 3 cm
SATFX-76	SML076-xx	Depending on the tube \varnothing	11 x 11.5 x 3 cm
SATFX-115	SML115-xx	Depending on the tube \varnothing	17 x 18 x 3 cm

To order the jaws, replace xx with the outside diameter of the tube you want to weld.
 Example: A set of jaws for clamping a tube with an outside diameter of \varnothing 38.10 mm = SML052-38.1

✓ SATFX-52	✓ SATFX-76	✓ SATFX-115
------------	------------	-------------



Clamping jaws adaptation spacers, thickness 8 mm, stainless steel

A set of spacers consists of **four half-shells** machined to the outside shape of the jaws concerned. It allows you to use the jaws of a machine of lower capacity. AXXAIR also offers adaptation spacers for jaws from other manufacturers. For further information, please contact us.

For Machine	Jaws that you can use	Product code	Net weight	Packaging (plastic)
SATFX-52	SATF-40NDHX	SMN052-ET40	0.2 kg	10 x 10 x 2.5 cm
SATFX-76	SATF-40NDHX	SMN076-ET40	0.5 kg	7.5 x 8 x 3 cm
	SATFX-52	SMN076-ET52	0.4 kg	7.5 x 8 x 3 cm
SATFX-115	SATF-40NDHX	SMN115-ET40	1.7 kg	7.5 x 8 x 3 cm
	SATFX-52	SMN115-ET52	1.2 kg	7.5 x 8 x 3 cm
	SATFX-76	SMN115-ET76	0.9 kg	11 x 11.5 x 3 cm

Example: With the spacer SMN115-ET76, you can use the jaws of the head SATFX-76 with the SATFX-115.

✓ SATFX-52	✓ SATFX-76	✓ SATFX-115
------------	------------	-------------



Orbital welding (Closed heads) - Accessories



NEW

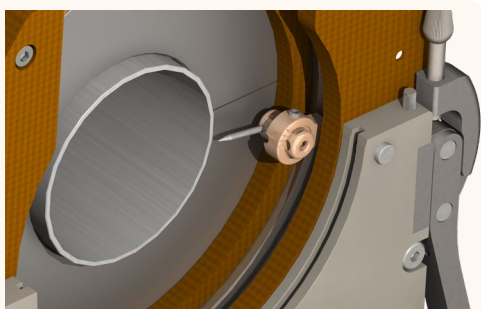
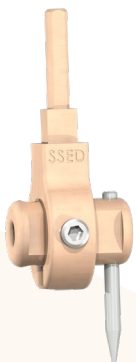

✓ SATFX-52

Product Code	Description	Net weight	Dimensions
SSEDX	Offset electrode support	0.008 kg	150 x 210 mm

Remote electrode holder for \varnothing 1.6 mm and \varnothing 2.4mm electrodes:

The SSEDX accessory allows a lateral displacement of 2 to 6.5mm from the original position which allows for the welding of short elbows for example.

If you use this system, the usable diameter range of the tube is reduced:

Machine	\varnothing min	\varnothing max
SATFX-52	6 mm	43 mm
SATFX-76	6 mm	67 mm
SATFX-115	12 mm	107 mm

See consumables to find the electrodes required for its use.

✓ SATFX-76

✓ SATFX-115

NEW

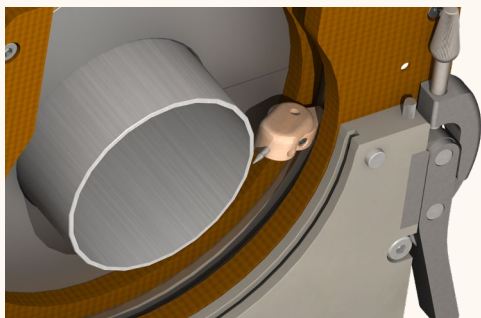

✓ SATFX-52

Product Code	Description	Net weight	Dimensions
SSEIX	Inclined electrode holder	0.015 kg	150 x 210 mm

Inclined electrode holder for \varnothing 1.6 mm and \varnothing 2.4mm electrodes:

The SSEIX accessory allows the electrode to be tilted from 0 ° to 45°, which makes it possible to produce angle welds (flange welds or other accessories).

If you use this system, the usable diameter range of the tube is reduced:

Machine	\varnothing min	\varnothing max
SATFX-52	6 mm	28 mm
SATFX-76	6 mm	52 mm
SATFX-115	12 mm	92 mm

See consumables to find the electrodes required for its use.

✓ SATFX-76

✓ SATFX-115



Orbital welding (Closed heads)
Accessories on request

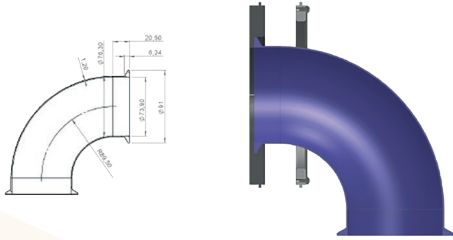

Ferrule – elbow – ferrule configuration (large diameter)

- Elbow end: adaptor jaws + gas protection side plates in stainless steel
- Ferrule end: special jaws

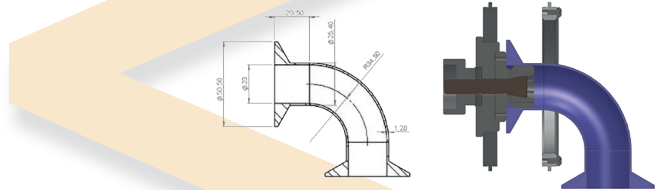

Ferrule – elbow – ferrule configuration (small diameter)

- Elbow end: adaptor jaws + gas protection side plates in stainless steel
- Ferrule end: special jaws

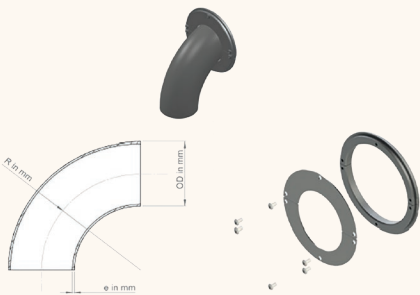

Tube – elbow configuration

- Tube end: standard jaws
- Elbow end: adaptor jaws + gas protection side plates in stainless steel

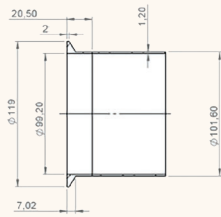

Tube – ferrule configuration

- Tube end: standard jaws
- Ferrule end: special jaws

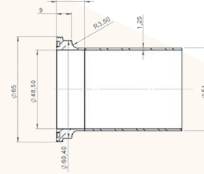

Tube – connector configuration

- Tube end: standard jaws
- Connector end: special jaws

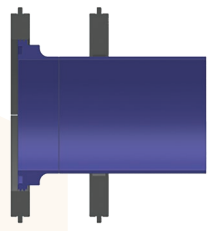

For any other specific requirements, please do not hesitate to contact us to examine the solutions that we can provide!



Orbital welding (Closed heads) - Consumables



Our electrodes are specifically sharpened to 20° with a flat. This increases the life of the electrodes.

Depending on the tube used, we offer cut electrodes.

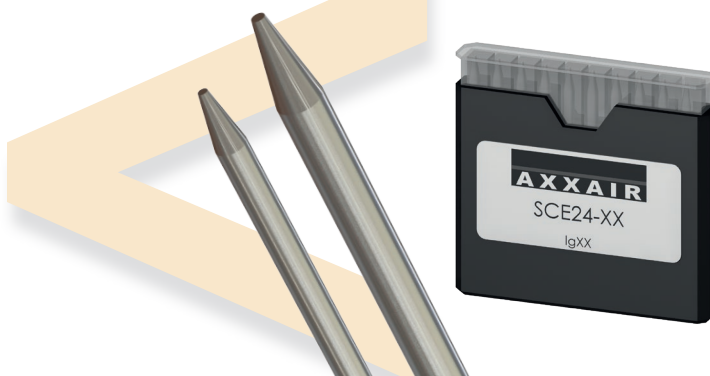

NEW

Electrodes for SATFX-52

ø of the Tube	Electrode Product Code ø1.6	Electrode Product Code ø2.4	Electrode length in mm
06 – 11,5 mm	SCE16-48	SCE24-48	48.0
11,5 – 18,5 mm	SCE16-44.5	SCE24-44.5	44.5
18,5 – 25,5 mm	SCE16-41	SCE24-41	41.0
25,5 – 32,5 mm	SCE16-37.5	SCE24-37.5	37.5
32,5 – 39,5 mm	SCE16-34	SCE24-34	34.0
39,5 – 46,5 mm	SCE16-30.5	SCE24-30.5	30.5
46,5 – 52 mm	SCE16-27	SCE24-27	27.0

✓ SATFX-52
SATFX-76
SATFX-115

NEW

Electrodes for SATFX-76

ø of the Tube	Electrode Product Code ø1.6	Electrode Product Code ø2.4	Electrode length in mm
06 – 7,5 mm	SCE16-62	SCE24-62	62.0
7,5 – 14,5 mm	SCE16-58.5	SCE24-58.5	58.5
14,5 – 21,5 mm	SCE16-55	SCE24-55	55.0
21,5 – 28,5 mm	SCE16-51.5	SCE24-51.5	51.5
28,5 – 35,5 mm	SCE16-48	SCE24-48	48.0
35,5 – 42,5 mm	SCE16-44.5	SCE24-44.5	44.5
42,5 – 49,5 mm	SCE16-41	SCE24-41	41.0
49,5 – 56,5 mm	SCE16-37.5	SCE24-37.5	37.5
56,5 – 63,5 mm	SCE16-34	SCE24-34	34.0
63,5 – 70,5 mm	SCE16-30.5	SCE24-30.5	30.5
70,5 – 76,1 mm	SCE16-27	SCE24-27	27.0

SATFX-52
✓ SATFX-76
SATFX-115



Orbital welding (Closed heads) - Consumables

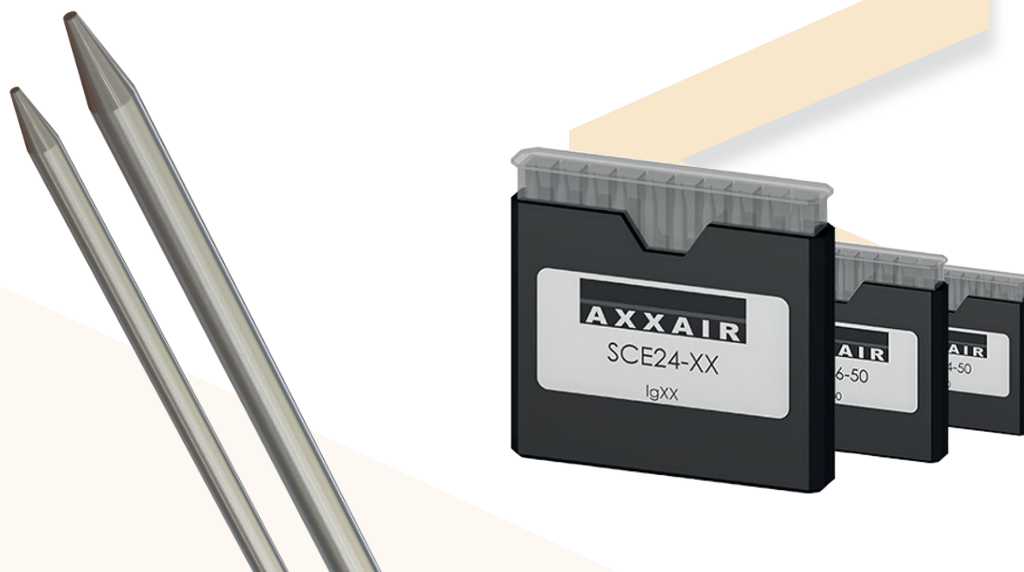

NEW Electrodes for SATFX-115

ø of the Tube	Electrode Product Code ø1.6	Electrode Product Code ø2.4	Electrode length in mm
12 – 19,5 mm	SCE16-76	SCE24-76	76.0
19,5 – 26,5 mm	SCE16-72.5	SCE24-72.5	72.5
26,5 – 33,5 mm	SCE16-69	SCE24-69	69.0
33,5 – 40,5 mm	SCE16-65.5	SCE24-65.5	65.5
40,5 – 47,5 mm	SCE16-62	SCE24-62	62.0
47,5 – 54,5 mm	SCE16-58.5	SCE24-58.5	58.5
54,5 – 61,5 mm	SCE16-55	SCE24-55	55.0
61,5 – 68,5 mm	SCE16-51.5	SCE24-51.5	51.5
68,5 – 75,5 mm	SCE16-48	SCE24-48	48.0
75,5 – 82,5 mm	SCE16-44.5	SCE24-44.5	44.5
82,5 – 89,5 mm	SCE16-41	SCE24-41	41.0
89,5 – 96,5 mm	SCE16-37.5	SCE24-37.5	37.5
96,5 – 103,5 mm	SCE16-34	SCE24-34	34.0
103,5 – 110,5 mm	SCE16-30.5	SCE24-30.5	30.5
110,5 – 115 mm	SCE16-27	SCE24-27	27.0

SATFX-52	SATFX-76	✓ SATFX-115
----------	----------	-------------



Orbital welding (Closed head) - Consumables

Electrodes when using the accessory SSEDX

AXXAIR

INNOVATIVE ORBITAL SOLUTIONS

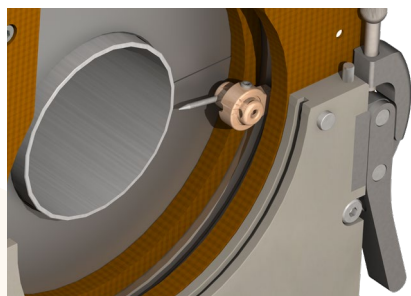

SSEDX : Remote electrode holder for $\varnothing 1.6$ mm and $\varnothing 2.4$ mm electrodes.

If you use this system, the usable diameter range of the tube is reduced.



Electrodes for SATFX-52 when using the accessory SSEDX

NEW

\varnothing of the Tube	Electrode Product Code $\varnothing 1.6$	Electrode Product Code $\varnothing 2.4$	Electrode length
06 - 13 mm	SCE16-27	SCE24-27	27.0 mm
09 - 16 mm	SCE16-25.5	SCE24-25.5	25.5 mm
11 - 18 mm	SCE16-24.5	SCE24-24.5	24.5 mm
16 - 23 mm	SCE16-22.0	SCE24-22.0	22.0 mm
18 - 25 mm	SCE16-21.0	SCE24-21.0	21.0 mm
20 - 27 mm	SCE16-20.0	SCE24-20.0	20.0 mm
22 - 29 mm	SCE16-19.0	SCE24-19.0	19.0 mm
23 - 30 mm	SCE16-18.5	SCE24-18.5	18.5 mm
24 - 31 mm	SCE16-18.0	SCE24-18.0	18.0 mm
25 - 32 mm	SCE16-17.5	SCE24-17.5	17.5 mm
30 - 37 mm	SCE16-15.0	SCE24-15.0	15.0 mm
36 - 43 mm	SCE16-12.0	SCE24-12.0	12.0 mm

Electrodes for SATFX-76 when using the accessory SSEDX

NEW

\varnothing of the Tube	Electrode Product Code $\varnothing 1.6$	Electrode Product Code $\varnothing 2.4$	Electrode length
06 - 09 mm	SCE16-41.0	SCE24-41.0	41.0 mm
09 - 16 mm	SCE16-37.5	SCE24-37.5	37.5 mm
16 - 23 mm	SCE16-34.0	SCE24-34.0	34.0 mm
23 - 30 mm	SCE16-30.5	SCE24-30.5	30.5 mm
30 - 37 mm	SCE16-27.0	SCE24-27.0	27.0 mm
33 - 40 mm	SCE16-25.5	SCE24-25.5	25.5 mm
35 - 42 mm	SCE16-24.5	SCE24-24.5	24.5 mm
40 - 47 mm	SCE16-22.0	SCE24-22.0	22.0 mm
42 - 49 mm	SCE16-21.0	SCE24-21.0	21.0 mm
44 - 51 mm	SCE16-20.0	SCE24-20.0	20.0 mm



Orbital welding (Closed head) - Consumables

AXXAIR

INNOVATIVE ORBITAL SOLUTIONS

Electrodes when using the accessory SSEDX

Electrodes for SATFX-76 when using the accessory SSEDX

ø of the Tube	Electrode Product Code ø1.6	Electrode Product Code ø2.4	Electrode length
46 - 53 mm	SCE16-19.0	SCE24-19.0	19.0 mm
47 - 54 mm	SCE16-18.5	SCE24-18.5	18.5 mm
48 - 55 mm	SCE16-18.0	SCE24-18.0	18.0 mm
49 - 56 mm	SCE16-17.5	SCE24-17.5	17.5 mm
54 - 61 mm	SCE16-15.0	SCE24-15.0	15.0 mm
60 - 67 mm	SCE16-12.0	SCE24-12.0	12.0 mm
SATFX-52		✓ SATFX-76	SATFX-115

NEW Electrodes for SATFX-115 when using the accessory SSEDX

ø of the Tube	Electrode Product Code ø1.6	Electrode Product Code ø2.4	Electrode length
12 - 14 mm	SCE16-58.5	SCE24-58.5	58.5 mm
14 - 21 mm	SCE16-55.0	SCE24-55.0	55.0 mm
21 - 28 mm	SCE16-51.5	SCE24-51.5	51.5 mm
28 - 35 mm	SCE16-48.0	SCE24-48.0	48.0 mm
35 - 42 mm	SCE16-44.5	SCE24-44.5	44.5 mm
42 - 49 mm	SCE16-41.0	SCE24-41.0	41.0 mm
49 - 56 mm	SCE16-37.5	SCE24-37.5	37.5 mm
56 - 63 mm	SCE16-34.0	SCE24-34.0	34.0 mm
63 - 70 mm	SCE16-30.5	SCE24-30.5	30.5 mm
70 - 77 mm	SCE16-27.0	SCE24-27.0	27.0 mm
73 - 80 mm	SCE16-25.5	SCE24-25.5	25.5 mm
75 - 82 mm	SCE16-24.5	SCE24-24.5	24.5 mm
80 - 87 mm	SCE16-22.0	SCE24-22.0	22.0 mm
82 - 89 mm	SCE16-21.0	SCE24-21.0	21.0 mm
84 - 91 mm	SCE16-20.0	SCE24-20.0	20.0 mm
86 - 93 mm	SCE16-19.0	SCE24-19.0	19.0 mm
87 - 94 mm	SCE16-18.5	SCE24-18.5	18.5 mm
88 - 95 mm	SCE16-18.0	SCE24-18.0	18.0 mm
89 - 96 mm	SCE16-17.5	SCE24-17.5	17.5 mm
94 - 101 mm	SCE16-15.0	SCE24-15.0	15.0 mm
100 - 107 mm	SCE16-12.0	SCE24-12.0	12.0 mm
SATFX-52		SATFX-76	✓ SATFX-115



Orbital welding (Closed head) - Consumables

Electrodes when using the accessory SSEIX

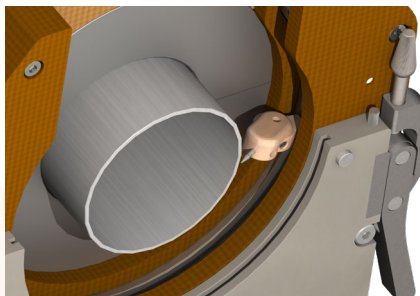

SSEIX : Inclined electrode holder for $\phi 1.6$ mm and $\phi 2.4$ mm electrodes.

If you use this system, the usable diameter range of the tube is reduced.



Electrodes for SATFX-52 when using the accessory SSEIX

ϕ of the Tube 0° inclined	ϕ of the Tube 15° inclined	ϕ of the Tube 30° inclined	ϕ of the Tube 45° inclined	Electrode Product Code $\phi 1.6$	Electrode Product Code $\phi 2.4$	Electrode length
-	-	-	6,00 - 12,61 mm	SCE16-27	SCE24-27	27 mm
-	-	-	7,73 - 14,73 mm	SCE16-25.5	SCE24-25.5	25,5 mm
-	-	-	9,14 - 16,14 mm	SCE16-24.5	SCE24-24.5	24,5 mm
-	-	-	12,68 - 19,68 mm	SCE16-22.0	SCE24-22.0	22 mm
-	-	6,00 - 12,38 mm	14,09 - 21,09 mm	SCE16-21.0	SCE24-21.0	21 mm
-	-	7,11 - 14,11 mm	15,50 - 22,50 mm	SCE16-20.0	SCE24-20.0	20 mm
-	-	8,85 - 15,85 mm	16,92 - 23,92 mm	SCE16-19.0	SCE24-19.0	19 mm
-	-	9,71 - 16,71 mm	17,63 - 24,63 mm	SCE16-18.5	SCE24-18.5	18,5 mm
-	6,00 - 12,70 mm	10,58 - 17,58 mm	18,33 - 25,33 mm	SCE16-18.0	SCE24-18.0	18 mm
6,00 - 12,50 mm	6,67 - 13,67 mm	11,44 - 18,44 mm	19,04 - 26,04 mm	SCE16-17.5	SCE24-17.5	17,5 mm
10,50 - 17,50 mm	11,50 - 18,50 mm	15,77 - 22,77 mm	22,58 - 29,58 mm	SCE16-15.0	SCE24-15.0	15 mm
16,5 - 23,5 mm	17,29 - 24,29 mm	20,97 - 27,97 mm	26,82 - 33,82 mm	SCE16-12.0	SCE24-12.0	12 mm

✓ SATFX-52

SATFX-76

SATFX-115

For special application only - Outside standard machine template

For application with jaws for flanges only



Orbital welding (Closed head) - Consumables

AXXAIR

INNOVATIVE ORBITAL SOLUTIONS

Electrodes when using the accessory SSEIX

Electrodes for SATFX-76 when using the accessory SSEIX

ø of the Tube 0° inclined	ø of the Tube 15° inclined	ø of the Tube 30° inclined	ø of the Tube 45° inclined	Electrode Product Code ø1.6	Electrode Product Code ø2.4	Electrode length
-	-	-	9,83 - 16,83 mm	SCE16-41.0	SCE24-41.0	41 mm
-	-	-	14,78 - 21,78 mm	SCE16-37.5	SCE24-37.5	37,5 mm
-	-	6,89 - 13,89 mm	19,73 - 26,73 mm	SCE16-34.0	SCE24-34.0	34 mm
6 - 10,5 mm	6,00 - 12,57 mm	12,95 - 19,95 mm	24,68 - 31,68 mm	SCE16-30.5	SCE24-30.5	30,5 mm
10,5 - 17,5 mm	12,34 - 19,34 mm	19,01 - 26,01 mm	29,63 - 36,63 mm	SCE16-27	SCE24-27	27 mm
13,5 - 20,5 mm	15,23 - 22,23 mm	21,61 - 28,61 mm	31,75 - 38,75 mm	SCE16-25.5	SCE24-25.5	25,5 mm
15,5 - 22,5 mm	17,17 - 24,17 mm	23,34 - 30,34 mm	33,16 - 40,16 mm	SCE16-24.5	SCE24-24.5	24,5 mm
20,5 - 27,5 mm	22,00 - 29,00 mm	27,67 - 34,67 mm	36,70 - 43,70 mm	SCE16-22.0	SCE24-22.0	22 mm
22,5 - 29,5 mm	23,93 - 30,93 mm	29,40 - 36,40 mm	38,11 - 45,11 mm	SCE16-21.0	SCE24-21.0	21 mm
24,5 - 31,5 mm	25,86 - 32,86 mm	31,13 - 38,13 mm	39,52 - 46,52 mm	SCE16-20.0	SCE24-20.0	20 mm
26,5 - 33,5 mm	27,79 - 34,79 mm	32,87 - 39,87 mm	40,94 - 47,94 mm	SCE16-19.0	SCE24-19.0	19 mm
27,5 - 34,5 mm	28,76 - 35,76 mm	33,73 - 40,73 mm	41,65 - 48,65 mm	SCE16-18.5	SCE24-18.5	18,5 mm
28,5 - 35,5 mm	29,72 - 36,72 mm	34,60 - 41,60 mm	42,35 - 49,35 mm	SCE16-18.0	SCE24-18.0	18 mm
29,5 - 36,5 mm	30,69 - 37,69 mm	35,46 - 42,46 mm	43,06 - 50,06 mm	SCE16-17.5	SCE24-17.5	17,5 mm
34,5 - 41,5	35,52 - 42,52 mm	39,79 - 46,79 mm	46,60 - 53,60 mm	SCE16-15.0	SCE24-15.0	15 mm
40,5 - 47,5 mm	41,31 - 48,31 mm	44,99 - 51,99 mm	50,84 - 57,84 mm	SCE16-12.0	SCE24-12.0	12 mm
SATFX-52			✓ SATFX-76	SATFX-115		

For special application only - Outside standard machine template

For application with jaws for flanges only

Join experience



Orbital welding (Closed head) - Consumables

Electrodes when using the accessory SSEIX

AXXAIR

INNOVATIVE ORBITAL SOLUTIONS

Electrodes for SATFX-115 when using the accessory SSEIX

NEW

ø of the Tube 0° inclined	ø of the Tube 15° inclined	ø of the Tube 30° inclined	ø of the Tube 45° inclined	Electrode Product Code ø1.6	Electrode Product Code ø2.4	Electrode length
-	-	-	20,13 - 27,13 mm	SCE16-62.0	SCE24-62.0	62 mm
-	-	-	25,08 - 32,08 mm	SCE16-58.5	SCE24-58.5	58,5 mm
-	-	10,51 - 17,51 mm	30,03 - 37,03 mm	SCE16-55.0	SCE24-55.0	55 mm
-	-	16,57 - 23,57 mm	34,98 - 41,98 mm	SCE16-51.5	SCE24-51.5	51,5 mm
12 - 15,5 mm	12,00 - 18,77 mm	22,64 - 29,64 mm	39,93 - 46,93 mm	SCE16-48.0	SCE24-48.0	48 mm
15,5 - 22,5 mm	18,53 - 25,53 mm	28,70 - 35,70 mm	44,88 - 51,88 mm	SCE16-44.5	SCE24-44.5	44,5 mm
22,5 - 29,5 mm	25,29 - 32,29 mm	34,76 - 41,76 mm	49,83 - 56,83 mm	SCE16-41.0	SCE24-41.0	41 mm
29,5 - 36,5 mm	32,05 - 39,05 mm	40,82 - 47,82 mm	54,78 - 61,78 mm	SCE16-37.5	SCE24-37.5	37,5 mm
36,5 - 43,5 mm	38,81 - 45,81 mm	46,89 - 53,89 mm	59,73 - 66,73 mm	SCE16-34.0	SCE24-34.0	34 mm
43,5 - 50,5 mm	45,57 - 52,57 mm	52,95 - 59,95 mm	64,68 - 71,68 mm	SCE16-30.5	SCE24-30.5	30,5 mm
50,5 - 57,5 mm	52,34 - 59,34 mm	59,01 - 66,01 mm	69,63 - 76,63 mm	SCE16-27	SCE24-27	27 mm
53,5 - 60,5 mm	55,23 - 62,23 mm	61,61 - 68,61 mm	71,75 - 78,75 mm	SCE16-25.5	SCE24-25.5	25,5 mm
55,5 - 62,5 mm	57,17 - 64,17 mm	63,34 - 70,34 mm	73,16 - 80,16 mm	SCE16-24.5	SCE24-24.5	24,5 mm
60,5 - 67,5 mm	62,00 - 69,00 mm	67,67 - 74,67 mm	76,70 - 83,70 mm	SCE16-22.0	SCE24-22.0	22 mm
62,5 - 69,5 mm	63,93 - 70,93 mm	69,40 - 76,40 mm	78,11 - 85,11 mm	SCE16-21.0	SCE24-21.0	21 mm

SATFX-52

SATFX-76

✓ SATFX-115

For special application only - Outside standard machine template

For application with jaws for flanges only



Orbital welding (Closed head) - Consumables

Electrodes when using the accessory SSEIX

AXXAIR

INNOVATIVE ORBITAL SOLUTIONS

NEW

Électrodes pour SATFX-115 (en cas d'utilisation de l'accessoire SSEIX)

ø of the Tube 0° inclined	ø of the Tube 15° inclined	ø of the Tube 30° inclined	ø of the Tube 45° inclined	Electrode Product Code ø1.6	Electrode Product Code ø2.4	Electrode length
64,5 - 71,5 mm	65,86 - 72,86 mm	71,13 - 78,13 mm	79,52 - 86,52 mm	SCE16-20.0	SCE24-20.0	20 mm
66,5 - 73,5 mm	67,79 - 74,79 mm	72,87 - 79,87 mm	80,94 - 87,94 mm	SCE16-19.0	SCE24-19.0	19 mm
67,5 - 74,5 mm	68,76 - 75,76 mm	73,73 - 80,73 mm	81,65 - 88,65 mm	SCE16-18.5	SCE24-18.5	18,5 mm
68,5 - 75,5 mm	69,72 - 76,72 mm	74,60 - 81,60 mm	82,35 - 89,35 mm	SCE16-18.0	SCE24-18.0	18 mm
69,5 - 76,5 mm	70,69 - 77,69 mm	75,46 - 82,46 mm	83,06 - 90,06 mm	SCE16-17.5	SCE24-17.5	17,5 mm
74,5 - 81,5 mm	75,52 - 82,52 mm	79,79 - 86,79 mm	86,60 - 93,60 mm	SCE16-15.0	SCE24-15.0	15 mm
80,5 - 87,5 mm	81,31 - 88,31 mm	84,99 - 91,99 mm	90,84 - 97,84 mm	SCE16-12.0	SCE24-12.0	12 mm

SATFX-52

SATFX-76

✓ SATFX-115

For special application only - Outside standard machine template

For application with jaws for flanges only

72

